

## Evaluation Of The Performance Of Front Winshield Wipers On Land Transport Safety

(The Study Was Conducted Using a Simulator Design of the Electric System of Windshield Wipers and Washer of Toyota Kijang KF80)

Nana Sumarna

A Lecturer Of The Faculty Of Technology And Vocational Education, Indonesia University Of Education

**ABSTRACT :** Rainwater, dust and exhaust gas chemicals from vehicles that stick to the surface of an automobile windshield are probably not an issue as long as the driver has an unobstructed view of the road. However, if the sticking substances are left unchecked, they will become a threat for travel safety.

Relying on the Front Windshield Wipers and Washer in order to clean the front windshield glass is not the final solution. Proper care is needed in order to ensure the cleanliness of the windshield glass. The area of the windshield glass of Toyota Kijang KF80 is  $0.964 \text{ m}^2$ . With the area covered by the wipe of the wiper blades as much as  $0.6162 \text{ m}^2$ , then the effectiveness of the wipe of the wiper blade is 63.92%. The comparison between worm gear and gear reduction is 8:1, with the reduction objective to lower the rotation of wiper motor and increase the moment of the wipe.

**Key words:** performance, front windshield wipers

### I. INTRODUCTION

The front windshield wiper system is one of the safety systems in a vehicle, which is categorized as a passive safety system because it only works when needed. The front windshield wipers function to ensure that the driver's view remains unobstructed when rain and or other natural disturbances occur.

As a supporting component of an automotive vehicle, a windshield wiper is one of the prerequisites of vehicle roadworthiness; therefore, the front windshield wipers on four-wheeled or more vehicles become an inseparable part. The number of wipers designed by the industry is 2 units on the front, with one vehicle being required to at least have one unit. The windshield wiper is not merely made to fulfill the requirements, but more ultimately it is built in order to abide by Law Number 22 of 2009, article 48, paragraph 2 on Traffic and Road Transport as part of the technical requirements for motor vehicles, and also function-wise the wipers can clean the windshield glass optimally.

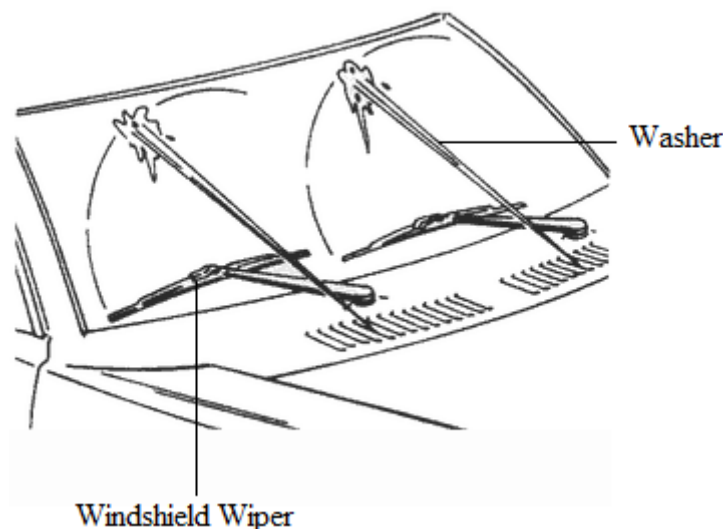

Picture 1: Windshield Glass and Wipers on a Car

The front windshield wipers work by wiping the windshield glass. The wipers have to work according to the needs: When drizzle occurs, the front windshield wipers have to move slowly so that the driver's view will not be obstructed by the movement of the wiper blades; while when it rains heavily, the windshield wipers must move quickly in order for the wiper blades to be able to clean water from the windshield glass maximally.

Nevertheless, based on Toyota Step 2 book, there are a few problems that sometimes occur in the front windshield wiper system, such as:wiper motoris unable to work at all positions (low speedand high speed);wiper motoris unable to work at low speed;wiper motoris unable to work at high speed;wiper motorstops at every position;when the switch is off, wiper motor works intermittently; wiper motoris unable to work together with washer;washer motoris unable to work;and the fuse system of the windshield wipersgets disconnectedbecause of a short circuit.

## II. THEORETICAL REVIEW

### 1. Front Windshield Wiper System

The front windshield wipersystem comprises several components,namely: wiper motor, which functions as the prime mover in windshield wiper system; wiper link, which functions to translate the rotationalmotion of wiper motorinto a translationalone; wiper armthat functions as wiper blade holder; and wiper blade, which serves aswindshieldglass cleaner.

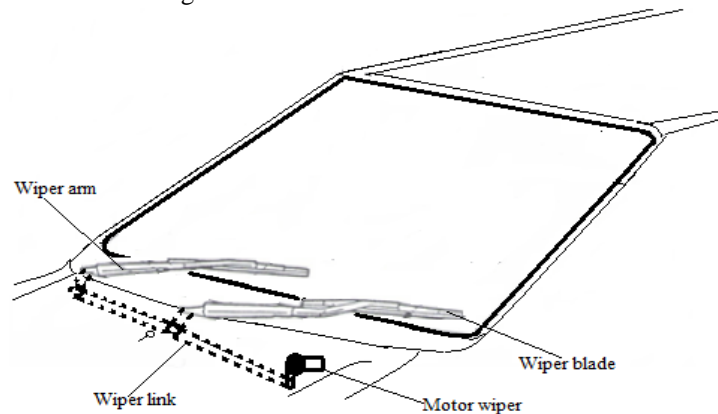

Picture 2: Windshield Wiper Construction

### 2. Howthe Front Windshield Wiper System Works

The prime mover of wipers is a magnetic motor with reduction gear. Generally, the working principle of the wipers can be described below:

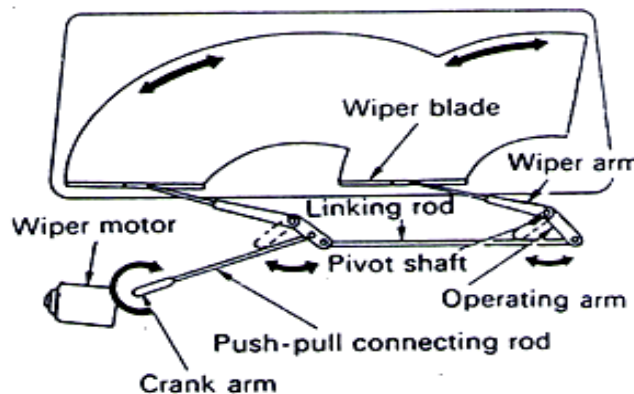

Picture 3:The Working Principle of Wipers

When motor is switched on, worm gear will rotate, causing the contact point to move and rotate the crank arm, which will then translate the rotational motion of the contact point into a translational motion on the push-pull connecting rod. Operating arm that is connected to the push-pull connecting rod will move the wiper arm on the pivot shaft,which will result inthe wiper blade making a half circle wipe on the windshield. The right and left sides of operating arm are connected by a linking rod, so that the motion of the left wiper blade and right wiper blade will be simultaneous.

### 3. General Review on the Basics of Electricity

#### a. Basics of Electricity

Electricity is one of the forms of energy that cannot be seen with the naked eye, but its effects and benefits can be perceived. The word comes from *electron*, which is a part of an atom. It is of two types, namely: static and dynamic electricity (Toyota, 1995:2-3).

#### b. Electric Power

The amount of work done per unit of time is called power (P), thus, the equation for power can be formulated below:

$$P = \frac{W}{t} = V \cdot I \quad (\text{Toyota 1995: 8-3})$$

Notes:

- P = Electric Power (Watt)
- W = Electric Energy (Joule)
- V = Voltage (Volt)
- I = Electric Current (Ampere)
- t = Time (second)

**c. The Working Principle**

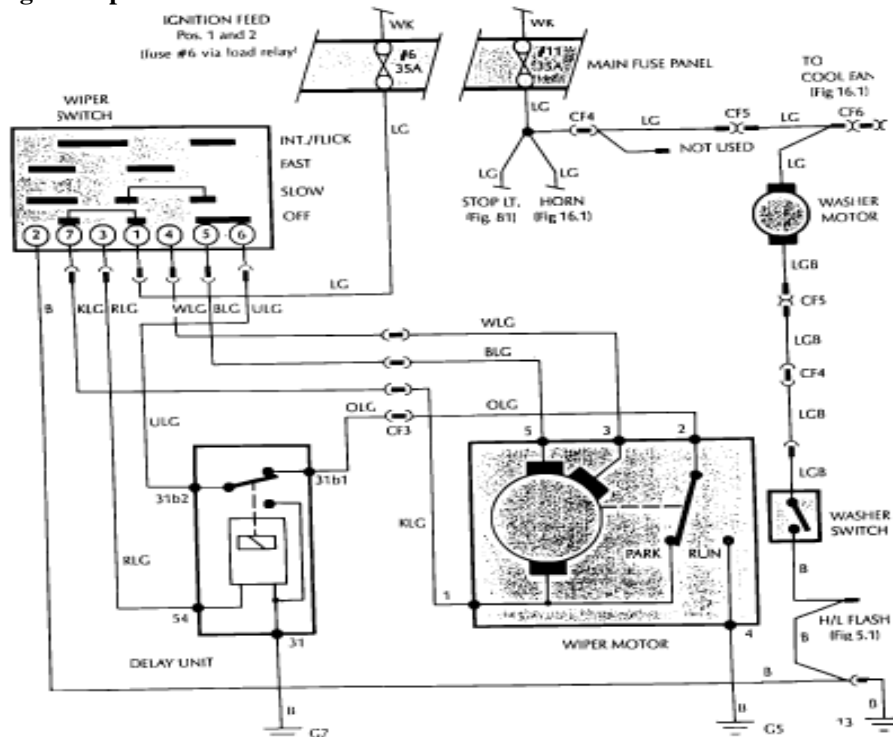

Picture 4: Windshield Wiper System Electrical Circuit

The working principle of wipers can be explained by the circuit above.

Terminals +1, +2, and (+) and (-) are located on wiper motor, and terminals LR1, LB1, LW and L on wiper switch, with terminal LR as a low speed terminal, LB = high speed terminal, and LW = auto stop negative terminal. At low speed, the current flows from L battery → LB<sub>1</sub> → +2 → B<sub>2</sub> → B<sub>3</sub> → (-) → body mass, and wiper motor will rotate quickly.

To turn on the front windshield wipers, move the lever to the desired setting.

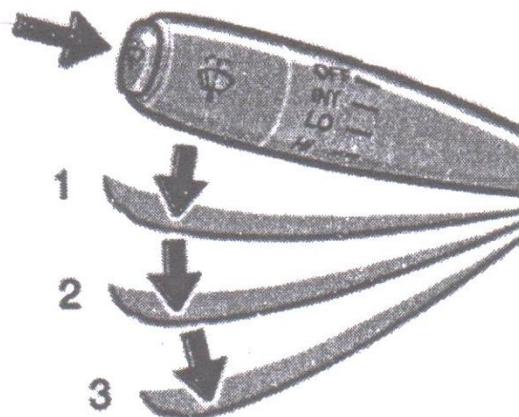

Fire switch must be in the "ON" position

Type A-

Lever Position	Speed Setting
Position 1	Intermittent
Position 2	Slow
Position 3	Fast

Picture 5: Type A Wiper Switch

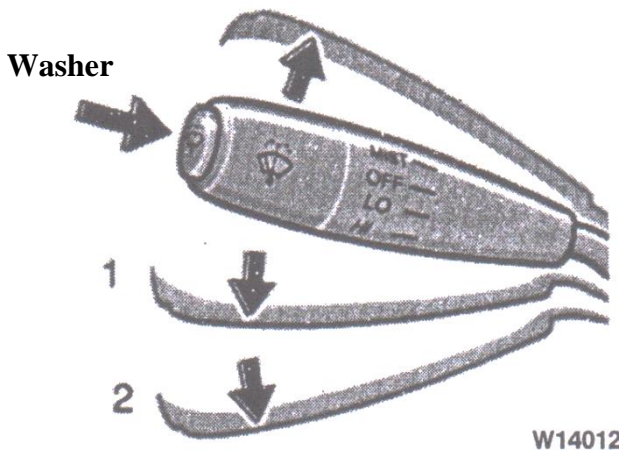

Picture 6: Type B Wiper Switch

Type B-

Lever Position	Speed Setting
Position 1	Slow
Position 2	Fast

#### 4. Washer System

Washer systems are used to complete the work of wiper blades in cleaning the windshield glass and reducing the burden of the motor while moving the wiper blades. Generally, the working principle of the washer is as follows: If the washer motor is activated, the impeller will rotate and transfer fluid out of the pump housing through the hose and to the nozzle.

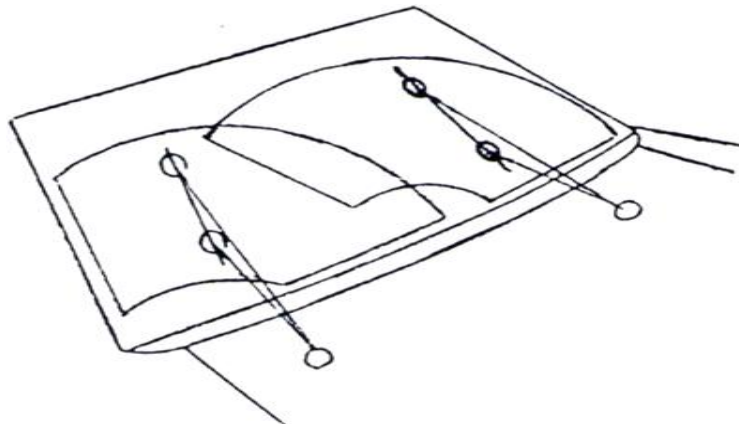

Picture 7: The Working Principle of the Washer

##### a. Washer Tank

The shape of a washer tank is varied depending on the available placement position.

##### b. Washer motor (Pump)

Washer motor functions to move the pump, which will then eject cleaning fluid from the tank. There are two types of washer motor, namely wound rotor and ferrite magnet. The ferrite magnet type is more commonly used in vehicles today.

##### c. Nozzle

Nozzle is made of copper, aluminum, or resin pipe with one or two holes. Currently, the widely used nozzle is resin nozzle with adjustable orifice.

### III. RESULT AND DISCUSSION

#### 1. Discussion of Motor Calculation

##### a. Motor Power (P)

1) Low speed  

$$P = I_1 \times V$$

$$= 3 \times 12$$

$$= 36 \text{ Watts}$$

2) High speed  

$$P = I_2 \times V$$

$$= 5 \times 12$$

$$= 60 \text{ Watts}$$

**b. Worm Gear and Gear Reduction Calculation**

Based on the measurements, the following data on worm gear and gear reduction are obtained:

Diameter of worm gear ( $d_1$ ) = 7,30 mm  
 Diameter of gear reduction ( $d_2$ ) = 61,30 mm

a) Comparison of Rotation ( $u$ )

$$u = \frac{d_1}{d_2} = \frac{7,30}{61,30} = 0,114$$

Based on the results of the calculation above, it is found that  $u < 1$ , so the comparison between  $d_1$  and  $d_2$  serves to reduce the rotation.

b) Comparison of Rotation between Worm Gear and Gear Reduction ( $u$ )

$$u = \frac{n_2}{n_1}$$

$$= \frac{1}{0,114}$$

$$= 8,77 \approx 8 \text{ Rotations}$$

So, the comparison of rotation between worm gear and gear reduction is 8 : 1 (8 worm gear rotations = 1 gear reduction rotation).

**1. Washer Motor Calculation**

**a. Discussion on Washer Motor Calculation**

Motor Power (P)

$$P = I \times V$$

$$= 0,5 \times 12$$

$$= 6 \text{ Watts}$$

**b. Calculation of Water Flow Discharge of the Washer**

The water flow discharge of the washer can be calculated by subtracting the volume of the washer tank by the end volume and then divided it by time.

$$D = \frac{V_0 - V_1}{t} \quad (\text{http://rangkuman-pelajaran.blogspot.com})$$

Where

D = Water Flow Discharge (liter/second)

$V_0$  = the initial volume of the tank ( $m^3$ )

$V_1$  = the end volume of the tank ( $m^3$ )

t = Time (second)

The initial volume of the washer tank is one liter and the end volume is 0.5 liter. The time needed to transfer 0.5 liter water is 5 minutes; therefore, the water flow discharge of the washer is:

$$V_0 = 1 \text{ liter}$$

$$V_1 = 0.5 \text{ liter}$$

$$t = 5 \text{ minutes} \approx 300 \text{ seconds}$$

Then

$$D = \frac{V_0 - V_1}{t}$$

$$= \frac{1 \times 10^{-3} - 5 \times 10^{-4}}{300}$$

$$= 0,0017 \text{ liter/second}$$

So, the water flow discharge of the washer is 0.0017 liter/second.

The water flow per one second in the washer consumes 0.0017 liter of cleaning water in the washer tank.

**2. The Effectiveness of Vehicle Front View**

The percentage of the wipe of wiper blades on the windshield glass can be found by dividing the area of the wiper blades' wipe on the windshield glass by the total area of the front windshield glass.

**a. The Area of the Front Windshield Glass**

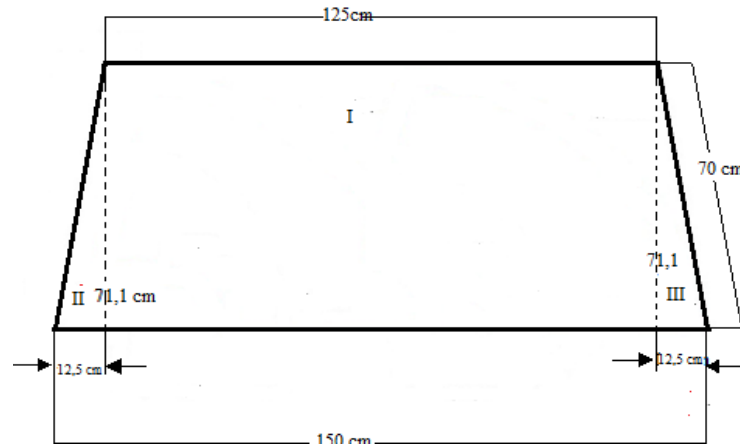

Picture 8: The Area of Front Windshield Glass

The total area of the front windshield glass can be counted by:

$$L_k = L_I + L_{II} + L_{III}$$

with,

$$\begin{aligned} L_I &= P \times L \\ &= 125 \times 70 \\ &= 8750 \text{ cm}^2 \end{aligned}$$

$$\begin{aligned} L_{II} &= \frac{1}{2} a \times t \\ &= \frac{1}{2} \cdot 12,5 \times 71,1 \\ &= 444,375 \text{ cm}^2 \end{aligned}$$

$$\begin{aligned} L_{III} &= \frac{1}{2} a \times t \\ &= \frac{1}{2} \cdot 12,5 \times 71,1 \\ &= 444,375 \text{ cm}^2 \end{aligned}$$

Then, the area of the front windshield glass is

$$\begin{aligned} L_k &= L_I + L_{II} + L_{III} \\ &= 8750 + 444,375 + 444,375 \\ &= 9638,75 \text{ cm}^2 \approx 0,964 \text{ m}^2 \end{aligned}$$

**b. The Area of Wiper Blades' Wipe on the Windshield Glass**

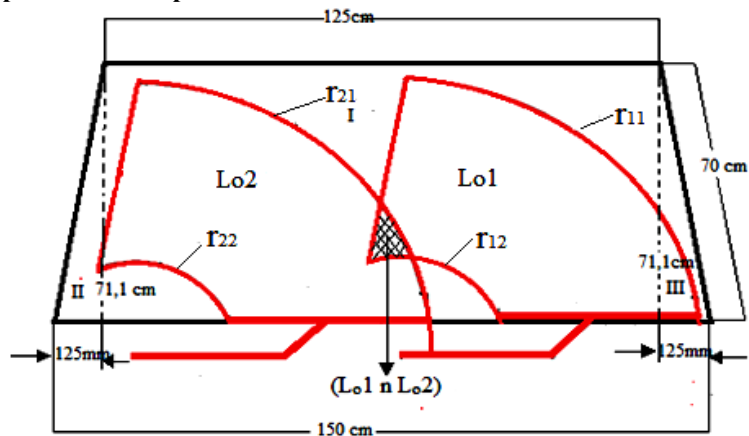

Picture 9: The Area of the Wipe of Wiper Blades on the Windshield Glass

1) The area of the first circle ( $L_{o1}$ )

$$\begin{aligned} L_{o1} &= L_{11} - L_{12} \\ L_{11} &= (\pi \cdot r_{11}^2) \\ &= 3,14 \cdot 68^2 \\ &= 14519 \text{ cm}^2 \end{aligned}$$

$$\begin{aligned} L_{12} &= (\pi \cdot r_{12}^2) \\ &= 3,14 \cdot 24^2 \\ &= 1808 \text{ cm}^2 \end{aligned}$$

$$\begin{aligned}
 L_{o1} &= L_{11} - L_{12} \\
 &= 14519 - 1808 \\
 &= 12711 \text{ cm}^2 \\
 L_s &= \frac{\beta}{360^\circ} \times L_{o1} \\
 &= \frac{93,48}{360^\circ} \times 12711 \\
 &= 3300,623 \text{ cm}^2 \approx 0,3300 \text{ m}^2
 \end{aligned}$$

- 2) The area of the second circle ( $L_{o2}$ )

$$\begin{aligned}
 L_{o2} &= L_{21} - L_{22} \\
 L_{21} &= (\pi \cdot r_{21}^2) \\
 &= 3,14 \cdot 67^2 \\
 &= 14095 \text{ cm}^2 \\
 L_{22} &= (\pi \cdot r_{22}^2) \\
 &= 3,14 \cdot 23^2 \\
 &= 1661 \text{ cm}^2 \\
 L_{o2} &= L_{21} - L_{22} \\
 &= 14095 - 1661 \\
 &= 12434 \text{ cm}^2
 \end{aligned}$$

$$\begin{aligned}
 L_s &= \frac{\beta}{360^\circ} \times L_{o2} \\
 &= \frac{84,8}{360^\circ} \times 12434 \\
 &= 2928,89 \text{ cm}^2 \approx 0,2928 \text{ m}^2
 \end{aligned}$$

Meanwhile, there is a slice on the result of the wipe of the wiper blades, so that:

$$\begin{aligned}
 L_s &= L_{s1} + L_{s2} - (L_{o1} \cap L_{o2}) \\
 &= 0,3300 + 0,2928 - (0,006624) \\
 &= 0,6162 \text{ m}^2
 \end{aligned}$$

The effectiveness of the wipe of the wiper blades on the windshield glass can be found by:

$$\begin{aligned}
 \text{Effectiveness} &= \frac{L_s}{L_k} \times 100\% \\
 &= \frac{0,6162}{0,964} \times 100\% \\
 &= 63.92\%
 \end{aligned}$$

#### IV. CONCLUSION

1. The current needed by wiper motor and washer
  - a. For low speed, the required current for the wiper motor is 3A.
  - b. For high speed, the required current for the wiper motor is 5A.
  - c. Intermittent wipers work by using wiper motor at low speed, so that the current required for intermittent wipers is the same as the current required for wiper motor at low speed, which is 3A.
  - d. The required current for washer motor is 0.5A.
2. Wiper motor and washer motor power
  - a. For low speed, wiper motor generates power as much as 36 Watts.
  - b. For high speed, wiper motor generates power as much as 60 Watts.
  - c. Washer motor generates power as much as 6 Watts.
3. Fuse Size  
The current that flows in the windshield wiper system is 9A, so that based on the results of the calculation, the fuse used is 15A.
4. The size of the conducting wire in the windshield wiper system is  $0.3 \text{ mm}^2$ .  
The size of the conducting wire in the washer system is  $0.3 \text{ mm}^2$ .
5. Based on the results of the calculation, the comparison of worm gear and reduction gear is 8:1; the ratio serves to reduce the rotation of the motor in order to increase moment.
6. The area of the wipe of the wiper blades
  - a. Based on the results of the calculation, the area of the front windshield glass of Toyota Kijang KF80 is  $0.964 \text{ m}^2$ .
  - b. Based on the results of the calculation, the area of the wipe of both wiper blades on the front windshield glass of Toyota Kijang KF80 is  $0.6162 \text{ m}^2$ .
  - c. Based on the results of the calculation, the effectiveness of the wipe of both wiper blades on the front windshield glass of Toyota Kijang KF80 is 63.92%.



#### REFERENCES

- [1] Bosch. (1986). *Automotive Handbook 2<sup>nd</sup>*. German Edition: Robert Bosch GmbH.
- [2] Djunaedi, Achmad. (Eds) (1995). *Perencanaan dan Teknik Lalu Lintas* (second Ed.). Yogyakarta: Gajah Mada University Perss.
- [3] Hobbs.F.D. (1995). *Perencanaan dan Teknik Lalu Lintas Edisi kedua*.
- [4] Yogyakarta: Gajah Mada University Perss
- [5] Hyundai. *Step 1 Electrical Basic electronic*. Hyundai Motor Company.
- [6] Jama, J. (2008). *Teknologi Sepeda Motor*. Jakarta: Direktorat Pengembangan SMK.
- [7] Katmasanti. (2011). *Rumus Pitagoras*. [Online]. Retrieved April 13, 2012 from: <http://riokatmasanti.blogspot.com/2011/12/rumus-pitagoras.html>.
- [8] The Republic of Indonesia. (2009). *Undang-Undang Nomor 22 Tahun 2009 tentang Lalu Lintas dan Angkutan Jalan*. Lembaran Negara RI Tahun 2009, No. 96. Sekretariat Negara. Jakarta.
- [9] Soekirno. (2009). *Trigonometri SMA*. [Online]. Retrieved April 13, 2012 from: <http://www.oke.or.id/2009/08/trigonometri-sma/>.
- [10] Sularso (Eds). (1997). *Dasar Perencanaan dan Pemilihan Elemen Mesin*. Jakarta: PradnyaParamita.
- [11] Sumarna, N. (2006). *Sistem Penerangan*. Bandung: JPTM FPTK UPI.
- [12] Sutrisno. (1984). *Fisika Dasar Gelombang dan Optik, Elektronika, Listrik dan Magnet*. Bandung: Penerbit ITB.
- [13] Suzuki (1995). *Dasar Kelistrikan dan Sistem Pengapian*. Jakarta: PT Indomobil Suzuki Internasional
- [14] Toyota. (1995). *New Step 1 Training Manual*. Jakarta: PT. Toyota Astra Motor.
- [15] Toyota. (1995). *New Step 2 Materi Pembelajaran Chasis Group*. Jakarta: PT. Toyota Astra Motor.
- [16] Toyota. (2000). *Toyota Electric Wiring Diagram*. Jakarta: PT. Toyota Astra Motor.